

型式系列 Series		NVC-5500	NVC-6500
使用流體 Fluid		空氣 Air	
Operating pressure [kgf/cm ²]	2位置單動 2 position single	1.5~7	
	2位置複動 2 position double	1.0~7	
	3位置 3 position	2.0~7	
有效斷面積mm ² (CV值) Orifice		12 (0.6)	14 (0.8)
配管口徑尺寸(G) Port Size		1/8"	1/4"
應達時間 [ms] Response time		12	19
電壓 Voltage	VDC	24, 12	
	VAC	110, 220 (50/60Hz)	
電壓容許範圍 Voltage tolerance		±10%	
周圍使用溫度 Ambient temperature		-10~60°C	
防護等級 IP Protection		IP50(插PIN式), IP65(出線式)	

底座選型 Base ordering Code

B M - 550 02

系列 Series

550	5500系列 Series
650	6500系列 Series

連數 Number of stations

02	2連座 Stations
03	3連座 Stations
⋮	⋮
20	20連座 Stations

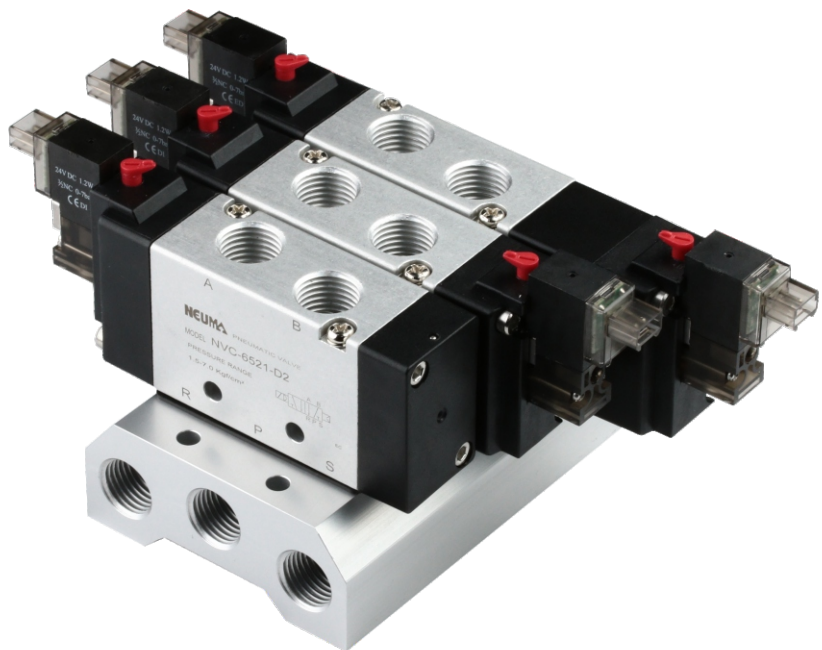

型式表示方法 Ordering Code

N V C - 5 5 2 1 - D2

系列 Series

5	NVC-5500
6	NVC-6500

切換方式 Type

2	二位置 2 position
3	三位置中間關閉 3 position close center
4	三位置中間開放 3 position open center
5	三位置中間壓力 3 position pressure center

線圈規格 Coil

1	單線圈 Single
2	雙線圈 Double

電壓 Voltage

A1	AC110V 50/60Hz
A2	AC220V 50/60Hz
D1	DC12V
D2	DC24V



尺寸圖 Dimension



NVC-6521

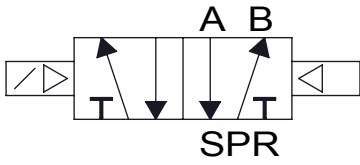

標準式(Standard)

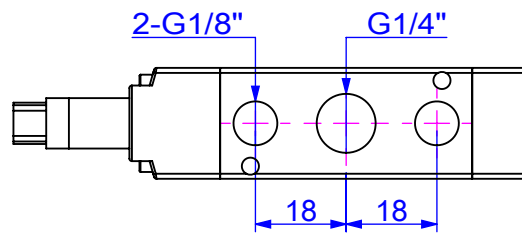
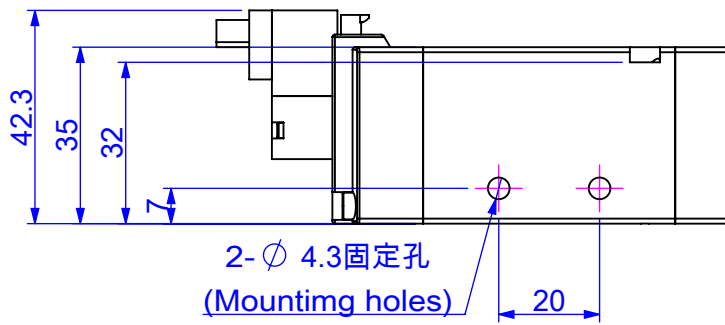
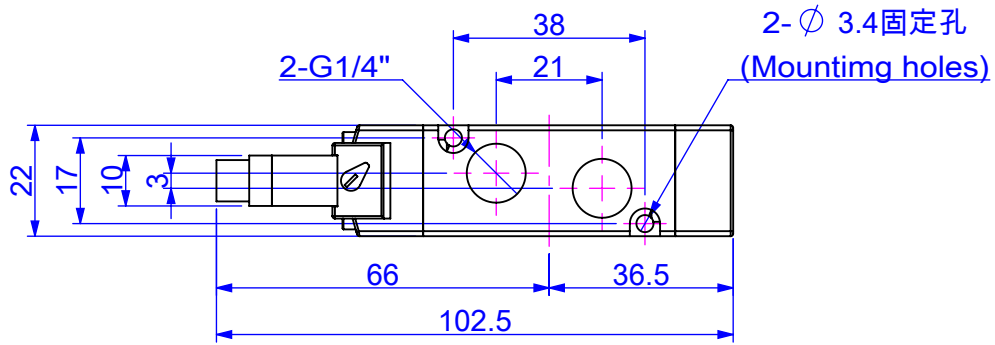

尺寸圖 Dimension



NVC-6522

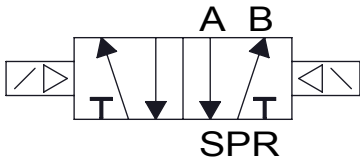

標準式(Standard)

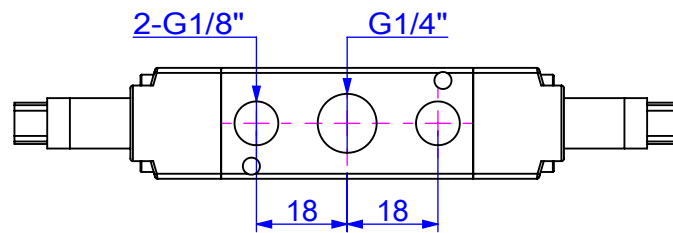
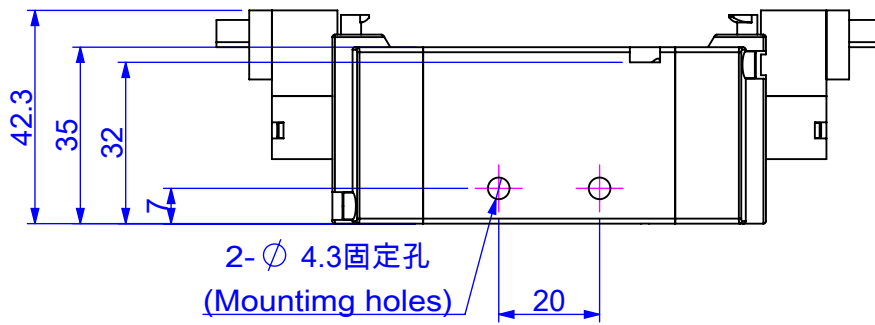
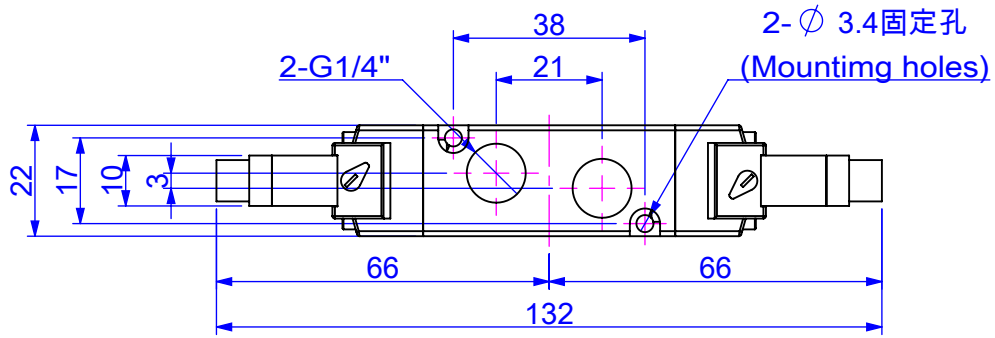

尺寸圖 Dimension



NVC-6532

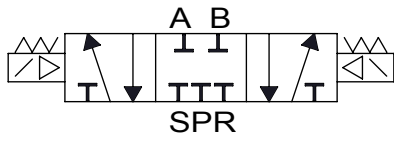

NVC-6542

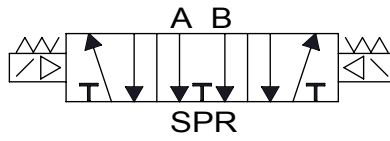

NVC-6552

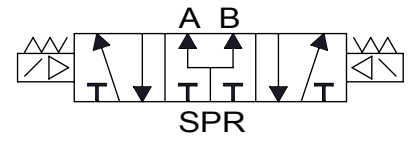

標準式(Standard)

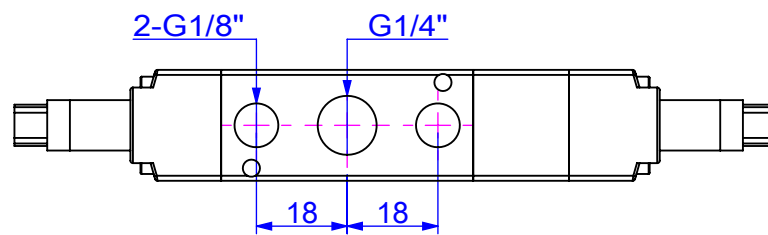
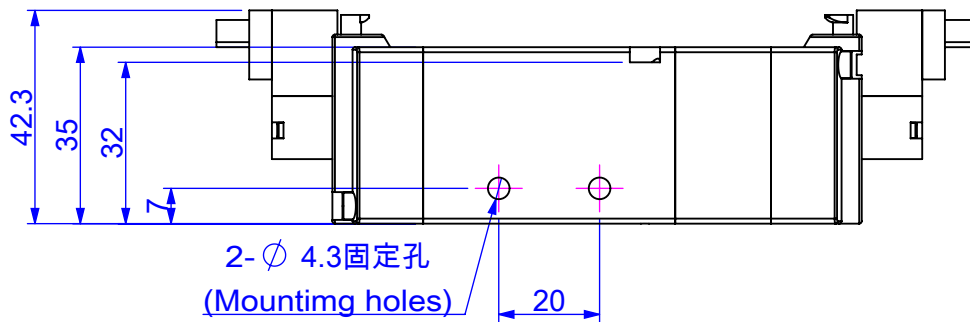
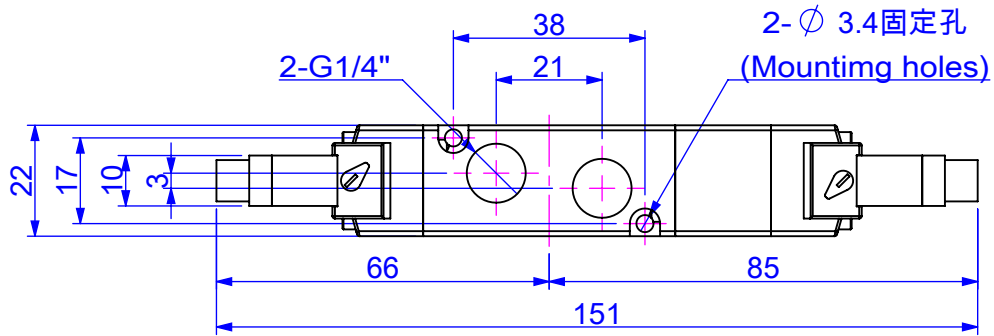

尺寸圖 Dimension

標準式(Standard)

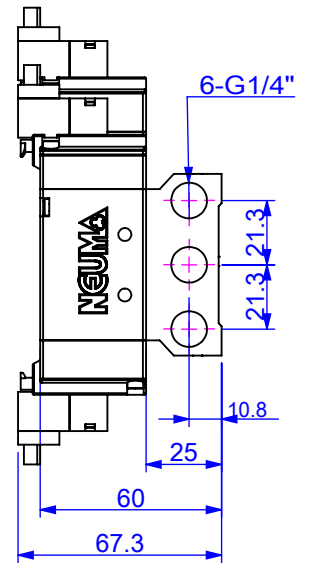
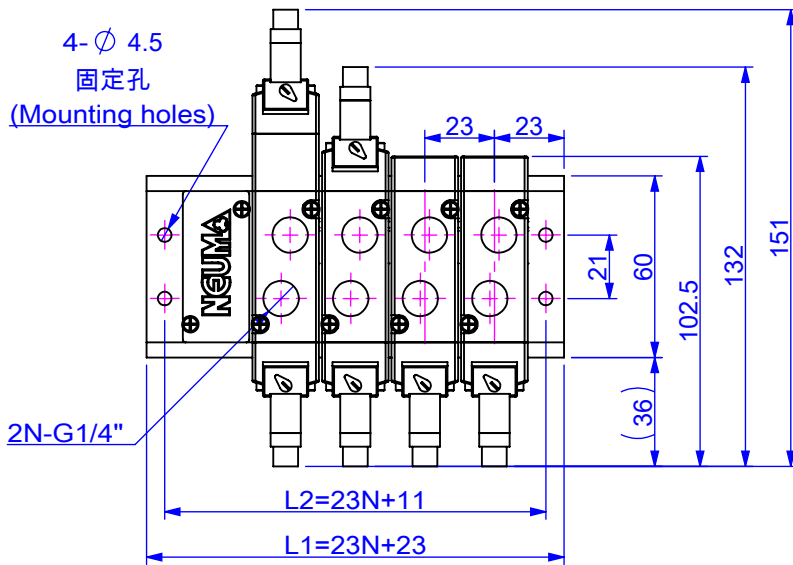

聯座數(N)	2	3	4	5	6	7	8	9	10
L1	69	92	115	138	161	184	207	230	253
L2	57	80	103	126	149	172	195	218	241

